

**EVOLUTION™**  
STEEL DECK FRAMING

# STEEL DECK FRAMING

**Rot? We Think Not.**

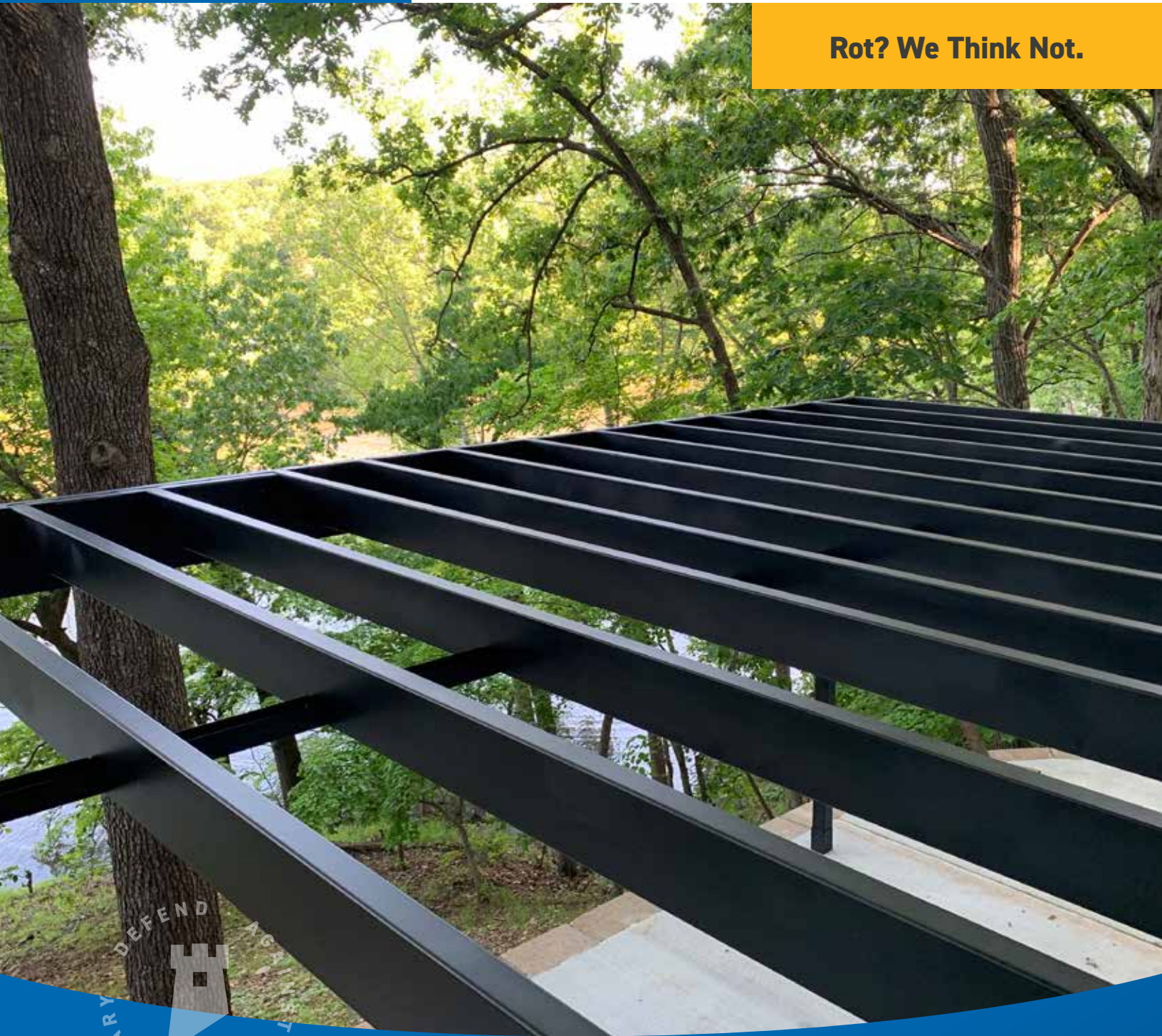

DEFEND AGAINST THE ORDINARY

**JOIN THE REVOLUTION.**  
FortressBP.com | 866.323.4766

**FORTRESS®**  
BUILDING PRODUCTS



Image shown using Fortress Evolution Steel Frame, Fortress Fe<sup>26</sup> Steel Railing in Blacksand attached with Fortress 2" Fascia Mount Brackets

## CHANGE STARTS FROM THE BOTTOM

Look underneath most decks and you'll see a weak link. Your decking and railing is engineered to last 25 years or more. So, why are you using wood framing? Choose Evolution steel deck framing, a smarter steel system designed by deck builders, for deck builders. The interlocking joist and ledger system lets you build sturdy, safe decks with less effort. Our powder-coated finish provides increased corrosion resistance and a more finished look.

**EASIER  
TO BUILD**

**SAFE,  
COMPLETE  
SYSTEM**

**LONG-LASTING  
FOR FEWER  
CALLBACKS**



### KEY FEATURES

- Looks and installs like wood
- Builds flat, stays flat!
- Provides greater spans between supports
- Works with any type or brand of decking, including composite, PVC, aluminum, tile, wood, and tropical hardwoods
- Carries a 25-year limited manufacturer warranty
- Designed for low-maintenance, durability, ease of installation, and safety
- The premium Black Sand powder coat virtually disappears when you're above or below your deck
- A noncombustible material, resistant to fire and invulnerable to rotting, warping, splitting, and pesky insect damage
- Wood boards are often soaked with insecticide and fungicide. Not steel
- Steel is recycled and recyclable, making it more sustainable than wood.

### BUILT TO LAST

#### 25-Year Limited Warranty

Evolution Steel Framing is designed to last as long as your pre-fabricated, pre-engineered railing and composite/synthetic decking. You no longer have to worry about replacing your deck framing when your decking and railing are still going strong. Our structural steel is dual-layer protected with Galvanization and Powder Coating to provide protection that will last.

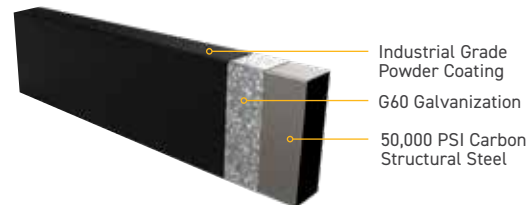

### A STEP ABOVE THE EXPECTED

Eliminate time and headaches with this innovative solution. The stair components and brackets work with the Evolution joist and beams to provide a quick, easy assembly, dramatically decreasing installation time!



## 16 GAUGE JOIST

Item #	Item Description	UPC #
181112161	FF-EVOLUTION-50mm x 150mm-3658mm-16GA-PC	811397030170
181114161	FF-EVOLUTION-50mm x 150mm-4267mm-16GA-PC	811397030163
181116161	FF-EVOLUTION-50mm x 150mm-4877mm-16GA-PC	811397030156
181118161	FF-EVOLUTION-50mm x 150mm-5486mm-16GA-PC	811397030149
181120161	FF-EVOLUTION-50mm x 150mm-6096mm-16GA-PC	811397030132

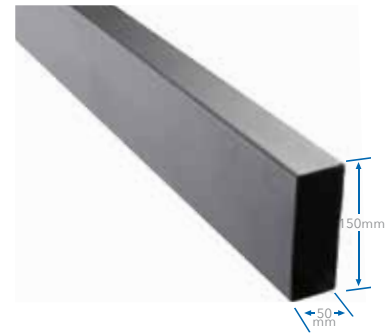

## 18 GAUGE JOIST

Item #	Item Description	UPC #
181112180	FF-EVOLUTION-50mm x 150mm-3658mm-18GA	811397030224
181114180	FF-EVOLUTION-50mm x 150mm-4267mm-18GA	811397030217
181116180	FF-EVOLUTION-50mm x 150mm-4877mm-18GA	811397030200
181118180	FF-EVOLUTION-50mm x 150mm-5486mm-18GA	811397030194
181120180	FF-EVOLUTION-50mm x 150mm-6096mm-18GA	811397030187



## BLANK S-LEDGER

Item #	Item Description	UPC #
182012141	FF-EVOLUTION-BLANK-S-LEDGER-3658mm	811397030293
182020141	FF-EVOLUTION-BLANK-S-LEDGER-6096mm	811397030309

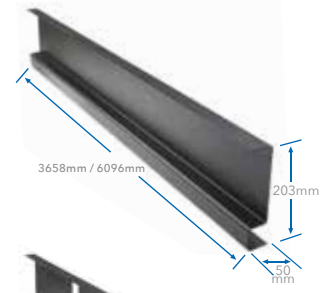

## 12" (305mm) | 16" (406mm) O.C. S-LEDGER

Item #	Item Description	UPC #
182112141	FF-EVOLUTION-12" (305mm) OC-S-LEDGER-3658 mm	811397030316
182120141	FF-EVOLUTION-12" (305mm) OC-S-LEDGER-6096 mm	811397030354
182212141	FF-EVOLUTION-16" (406mm) OC-S-LEDGER-3658 mm	811397030330
182220141	FF-EVOLUTION-16" (406mm) OC-S-LEDGER-6096 mm	811397030347

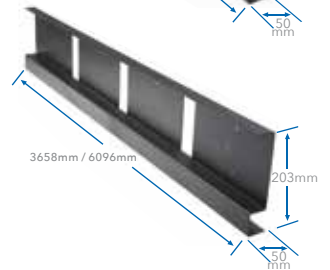

## BEAM

Item #	Item Description	UPC #
184108161	FF-EVOLUTION-BEAM 50mm x 280mm-2438 mm	811397030361
184112161	FF-EVOLUTION-BEAM 50mm x 280mm-3658 mm	811397030378
184116161	FF-EVOLUTION-BEAM 50mm x 280mm-4877 mm	811397030385
184120161	FF-EVOLUTION-BEAM 50mm x 280mm-6096 mm	811397030392



## DOUBLE BEAM TRACK

Item #	Item Description	UPC #
184204161	FF-EVOLUTION-DBL BEAM TRACK-1219mm (2 PACK)	811397030408

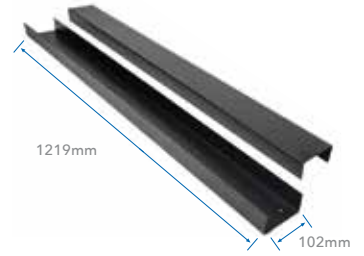

## 12" (305mm) | 16" (406mm) O.C. RIM JOIST

Item #	Item Description	UPC #
185008141	FF-EVOLUTION-12" (305mm) OC U-RIM JOIST-51mm X 152mm-2438mm	811397030415
185108141	FF-EVOLUTION-16" (406mm) OC U-RIM JOIST-51mm X 152mm-2438mm	811397030422

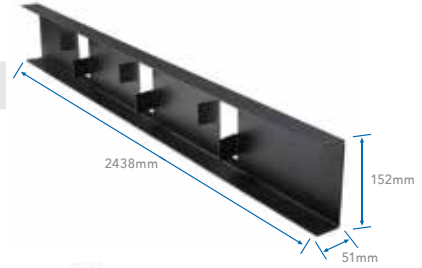

## BLANK RIM JOIST

Item #	Item Description	UPC #
185208141	FF-EVOLUTION-U-RIM JOIST-51mm x 152mm-2438mm	811397030439

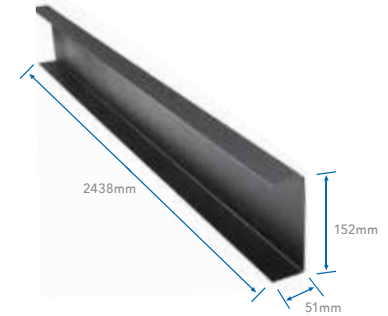

## CURVED RIM JOIST

Item #	Item Description	UPC #
185308161	FF-EVOLUTION-CURVE-RIM JOIST-51mm x 152mm-2438mm	811397030446

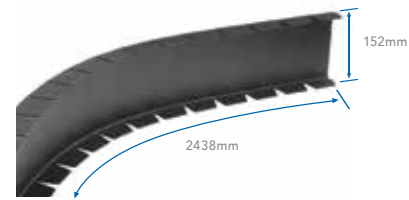

## LEDGER BRACKET

Item #	Item Description	UPC #
183011401	FF-EVOLUTION-LEDGER BRACKET	811397030125



## F-50 BRACKET

Item #	Item Description	UPC #
183021601	FF-EVOLUTION-F50 BRACKET	183021601



## 45° BRACKET

Item #	Item Description	UPC #
183451401	FF-EVOLUTION-45 DEG BRACKET	811397030101



## RIM JOIST BRACKET

Item #	Item Description	UPC #
183031801	FF-EVOLUTION-RIM JOIST BRACKET	811397030095

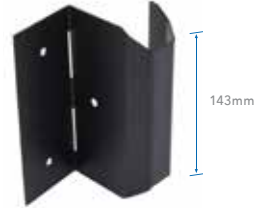

## F-10 BRACKET

Item #	Item Description	UPC #
183041601	FF-EVOLUTION-F10 BRACKET	811397030453



## SINGLE HANGER BRACKET

Item #	Item Description	UPC #
183102001	FF-EVOLUTION-SNGL HANGER BRACKET	811397030071



## DOUBLE HANGER BRACKET

Item #	Item Description	UPC #
183202001	FF-EVOLUTION-DBL HANGER BRACKET	811397030064



## SINGLE BEAM/POST BRACKET

Item #	Item Description	UPC #
183161601	FF-EVOLUTION-SNGL BEAM/POST BRACKET	811397030057

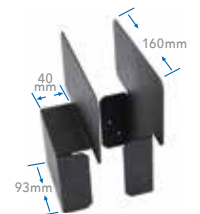

## DOUBLE BEAM/POST BRACKET

Item #	Item Description	UPC #
183261601	FF-EVOLUTION-DBL BEAM/POST BRACKET	811397030040

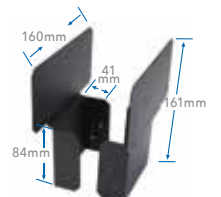

## 12" (305mm) | 16" (406mm) O.C. BLOCKING

Item #	Item Description	UPC #
188122001	FF-EVOLUTION-12" (305mm) OC BLOCKING	811397030033
188162001	FF-EVOLUTION-16" (406mm) OC BLOCKING	811397030026



## 12" (305mm) | 16" (406mm) O.C. STRAP

Item #	Item Description	UPC #
187104201	FF-EVOLUTION-12" (305mm) OC STRAP	811397030002
187204201	FF-EVOLUTION-16" (406mm) OC STRAP	811397030019

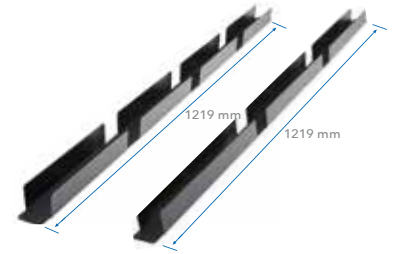

## POST

Item #	Item Description	UPC #
186110111	FF-EVOLUTION-POST 90mm x 90mm x 3048mm	811397030248

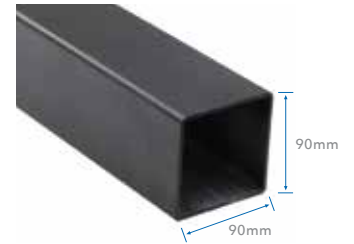

## POST/PIER BRACKET

Item #	Item Description	UPC #
183351601	FF-EVOLUTION-92mm POST/PIER BRACKET	811397030286



## BEAM CAP

Item #	Item Description	UPC #
183112001	FF-EVOLUTION-BEAM CAP	811397030279



## JOIST CAP

Item #	Item Description	UPC #
183062001	FF-EVOLUTION-JOIST CAP	811397030262



## 7"/11" (177mm/279mm) STAIR BRACKET

Item #	Item Description	UPC #
189107161	FF-EVOLUTION -177mm x 279mm STAIR BRACKET	811397030651

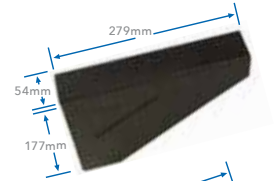

## 7-3/4" /11 (196mm/279mm) STAIR BRACKET

Item #	Item Description	UPC #
189134161	FF-EVOLUTION-196mm x 279mm STAIR BRACKET	811397030668

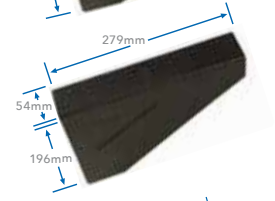

## ADJUSTABLE STAIR BRACKET

Item #	Item Description	UPC #
189199141	FF-EVOLUTION -ADJUSTABLE STAIR BRACKET	811397030705

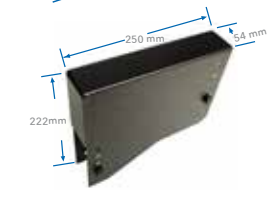

## STAIR STRAP

Item #	Item Description	UPC #
189223181	FF-EVOLUTION - STAIR STRAP 38mm x 572mm	811397030675



## ANCHOR BRACKET

Item #	Item Description	UPC #
189100161	FF-EVOLUTION STAIR ANCHOR BRACKET	811397030682



## STAIR TRAY

Item #	Item Description	UPC #
189348161	FF-EVOLUTION -1219mm STAIR TRAY	811397030712

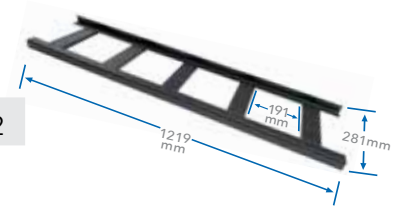

## SELF TAPPING SCREW

Item #	Item Description	UPC #
183990341	FF-EVOLUTION 19mm BLACK SELF-DRILLING SCREW (BAG 250)	811397030255



## BLACK SAND AEROSOL TOUCH UP PAINT

Item #	Item Description	UPC #
183280601	FF-BLACK SAND (BKSND) AEROSOL TOUCH UP PAINT	811397030736





**JOIN THE REVOLUTION.**  
FortressBP.com | 866.323.4766

## CHANGE STARTS FROM THE BOTTOM

Look underneath most decks and you'll see a weak link. Your decking and railing is engineered to last 25 years or more. So, why are you using wood framing? Choose Evolution steel deck framing, a smarter steel system designed by deck builders, for deck builders. The interlocking joist and ledger system lets you build sturdy, safe decks with less effort. Our powder-coated finish provides increased corrosion resistance and a more finished look.