



TruNorth Slide & Go Fence Installation Guide





Table of Contents

Table of Contents	1
Before You Build	2
About the TruNorth Slide & Go Fence	2
Quick Tips	2
Tools You'll Need	2
Installation Instructions	3
Mapping Out the Posts	3
Digging the Post Holes	3
Placing the Posts	3
Pouring the Concrete	4
Preparing the Channels	4
Installing the First Channel	5
Installing the Remaining Channels	5
Installing the First Board	6
Leveling the Ground	6
Installing the Remaining Baseboards	7
Installing the Remaining Enviroboards + Spacers	8
Trimming the Posts	9
Installing Top and Bottom Cap Rails	9
Installing the Post Caps	9

Before You Build

About the TruNorth Slide & Go Fence

The TruNorth Slide & Go Fence is specifically designed for homeowners who want a warm and private low-maintenance fence, with the stability and endurance of an aluminum fence, that is also easy to install. Follow these simple steps to have a beautiful, high-quality horizontal fence in no time!

Note: This fencing system uses TruNorth Decking Enviroboards and Tahoe Slipfence aluminum components. We recommend using a drill bit at least 4" long.

The fence posts are available in 6', 9'4", 10'4", and 12'4" lengths.

Quick Tips

- Ensure that you read this entire installation guide before you start your project
- Follow proper fastening methods as per this installation guide
- Do not overtorque screws
- For a fence on unlevel ground, it may work and look better if the posts are closer together
- Remember - you can use more than one colour of Enviroboard in your design
- Fence boards should not be touching soil/dirt. The warranty will be voided if the fence is used as a retaining wall to hold soil

Tools You'll Need

- Drill
- Level
- Rubber Mallet
- Saw

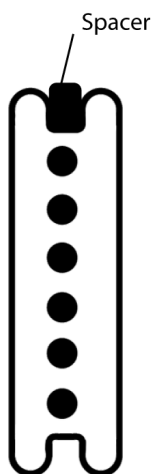

Top Down View

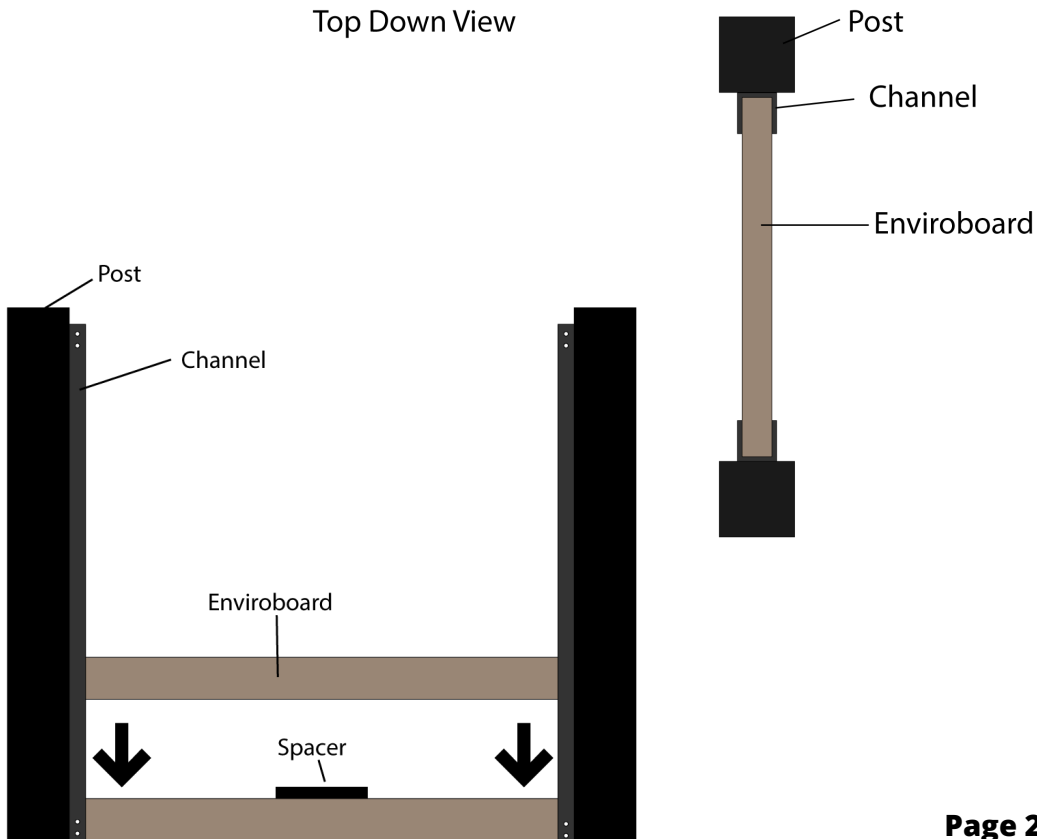

Storage & Handling

Prior to installation, allow the material to climatize itself (Ex. Lay out the boards overnight). Deck boards should be stored on a flat surface and covered. If the surface is not flat, the boards should be supported every 24" to prevent warping/sagging..

Installation Instructions

Mapping Out the Posts

When planning your Slide & Go Fence installation, make sure to map out your fence posts exactly 6' between posts.

Note: You may choose any length shorter than 6', but 6' is our maximum length.

Digging the Post Holes

Dig 8" diameter post holes 36" to 48" deep. If required, fill the bottom with a few inches of gravel (your local building code or colder climates may require a deeper post hole). Longer 10'4" and 12'4" posts are available when deeper holes are required.

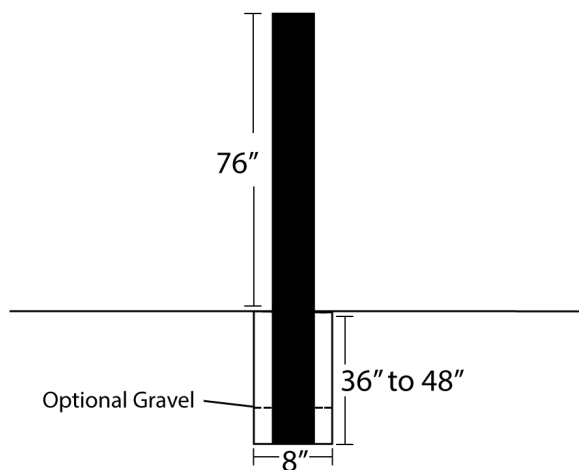

Placing the Posts

Insert the square aluminum post into the hole. For a 6' fence, ensure that the post is at least 76" from the ground to the top of the post. For a fence on unlevel ground, it may be easier to install, and look better, if the posts are closer together at an incline or decline. Be sure to read the "Leveling the Ground" section.

Pouring the Concrete

Follow the directions provided with the concrete mix you have chosen. Pour concrete into the hole around the post to set. While the concrete is still wet, lay a 6' board on the ground to make sure you have the proper spacing between your posts.

Hold the post level on both the X and Y axis, and make sure there is at least 76" from the ground to the top of the post while the concrete is drying. This helps eliminate trimming posts after the fence is complete.

Repeat this procedure for all posts in your fence project.

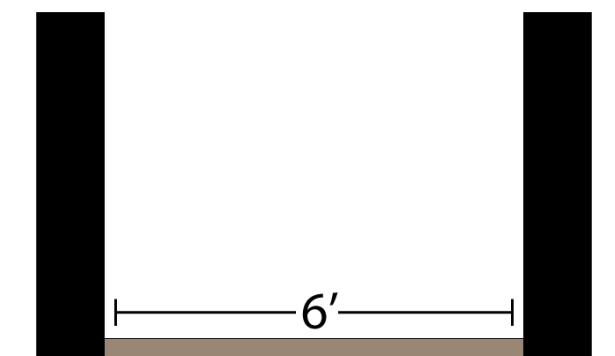

Preparing the Channels

When the concrete has dried, place one of your Enviroboards flat on the ground, between your posts, and shim it up to level. You can use some of the dirt removed from the hole to shore up the one end to level. This provides the proper space off the ground (about 1") for your first channels to be fastened to your first 2 posts.

Installing the First Channel

Place one channel against the side of the post that faces the next post, as close to the centre of the post as possible. Sitting it on top of the board that you had laid flat on the ground, level this channel on the centre of the post, then fasten to the post with the stainless self-drilling screws provided in the kit.

Note: The channels have more fence board screw holes on one side than the other. Keep this in mind when installing to get the look you want on each side of the fence.

Back side view

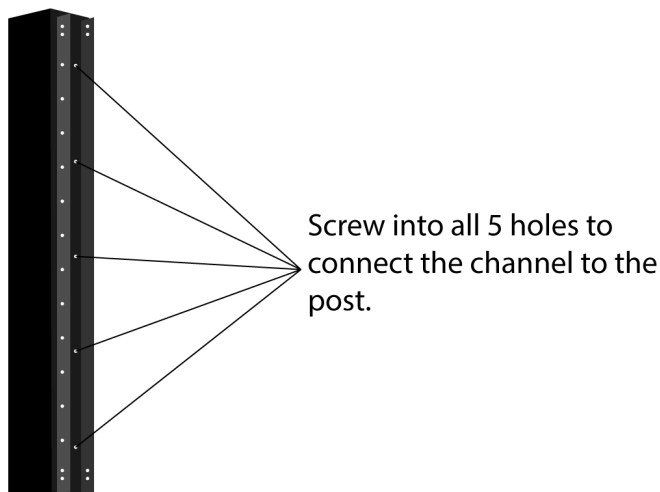

Installing the Remaining Channels

Once the first channel is fastened to the first post, ensure that the board laid flat on the ground is still level. This will be the seat for the channel on your next post to sit on.

Like the first channel, set it as close to the centre of the post as possible and level the channel on the post. Then, fasten the channel to the second post with the self-drilling screws provided, and you should now have 2 channels facing each other between 2 posts that are exactly level with each other.

Installing the First Board

Make sure that there is an appropriately sized gap between the edges of the boards and the channel, based on the temperature at the time of installation. This will allow the boards to expand without bowing in extreme heat.

- Temperatures **above** 21°C/70°F: Leave a **1/8"** gap between each end and the channels, for a total of **1/4"** shorter than the space between the channels
- Temperatures **below** 21°C/70°F: Leave a **1/4"** gap between each end and the channels, for a total of **1/2"** shorter than the space between the channels

Note: The 4 holes on the first board should be pre-drilled with a 7/64 drill bit before the screws are installed. This allows for some expansion of the boards and takes pressure off the screws.

Slide the first bottom, or "baseboard", between the channels. This first board slides down into the channels, sits level on the flat board laid on the ground, and screws into both of the channels with 4 screws on both sides and each end.

- A 6' high fence will take 14 boards stacked

Leveling the Ground

If the ground is fairly level, you can leave the flat board that was used to level the bottom of the channels in place and start your base-board at this level. This will provide a 1" lift of your bottom board off the ground.

If the ground is *not* level and one end of your panel has a gap from the bottom of the board to the ground, you can do one of the following 4 methods to reduce that gap:

- A. Take the dirt that was dug out of the post hole and spread it along the bottom underneath the baseboard where the gap is.
- B. Dig out some of the dirt from the side of the baseboard that is closest to the ground until the baseboard is level and there is little gap underneath.
- C. Shorten the space between the posts so the level step sections are shorter, and the gap can be covered more easily using method A or B.

- D. If there is a large gap under one side of the panel, keep the flat board laying on the ground. Level your baseboard on top of this board and measure the gap on the wide end, between the flat board laying on the ground and the bottom of your baseboard and the length of where the baseboard touches the flat board.

Then remove the baseboard and create a wedged board, to be fastened to the bottom of this panel. Once this new baseboard has been created, insert it into the bottom as your baseboard again, and it should now be level on top and close in the gap on the bottom.

Installing the Remaining Baseboards

Install all of your baseboards in your fence line *before* starting to stack the other boards in the panel. This will keep the posts level in your fence project during installation and prevent them from pulling toward the finished panel.

Correct:

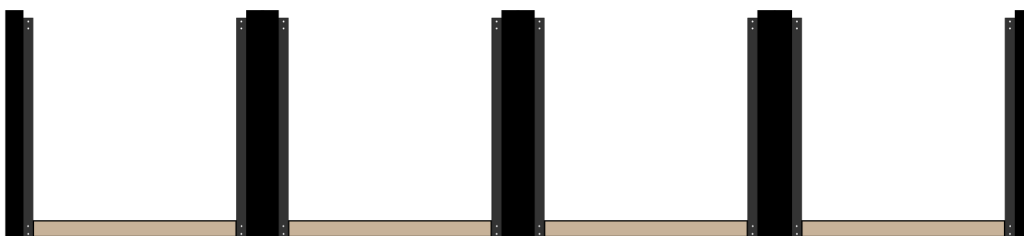

Incorrect:

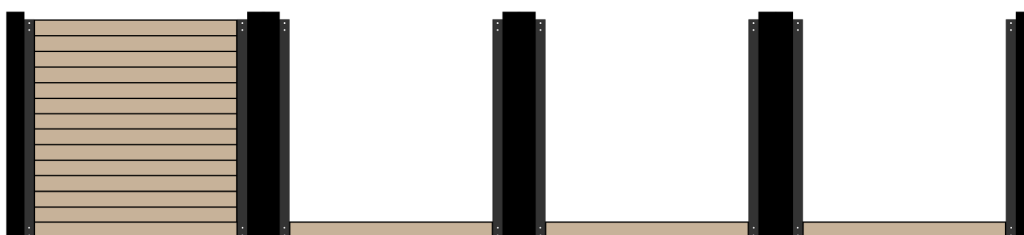

Installing the Remaining Enviroboards + Spacers

Once the baseboard is secured with the screws provided, slide 3 or 4 more Enviroboards into the channels on top of the baseboard on each panel. Add 2 spacers between *every* board, evenly spread apart, to create an even space between each board. Secure these few boards with screws through the screw holes in the channels as they stack to reduce the overall weight of the full stack of boards on the bottom baseboard.

Note: Do *not* stack or finish 1 full panel at a time. This could pull posts toward the finished panel. Create a low stack on *each* panel of the fence line (4 or 5 boards), then mid height (another 4 or 5 boards), then the top (last 4+ boards) until the desired height of your fence is met.

Repeat these steps to secure and stack all Enviroboards into all the panels of your Slide & Go Fence, making sure the stacks of boards remain level as you slide in the boards.

Note: If there is a slight curve in the Enviroboard, ensure that it is placed so that the sides curve up (*like a smile*). Use some force to pull one side down, secure it with a screw, then do the same on the other side. The curve should now be gone.



Trimming the Posts

Once all the boards have been inserted and the fence looks complete, you can now trim the tops of the posts, if necessary, with a metal blade on your saw.

If posts need to be cut down, a metal blade on a circular saw can be used on one side of the post, and then finished with a metal blade on a reciprocating saw.

If *only* a reciprocating saw is available, the first few cuts should be done with a hacksaw to provide a blade guide and help eliminate the reciprocating blade from jumping and chopping at the initial cut of the post.

Installing Top and Bottom Cap Rails

If using cap rails, simply fit them to the top or bottom (or both) Enviroboard and tap with a rubber mallet until secured tightly.

Installing the Post Caps

Place a self-tightening aluminum post cap on the top of each post. Tap each with a rubber mallet until secured tightly. Post caps should sit approximately 2" above the top of the fence boards for a nice clean appearance.

Thank you for choosing TruNorth Decking!

Please share your photos/videos of your Slide & Go Fence project on social media and tag us!

Scan this QR code with your device to easily:

- View our website (trunorthdecking.com)
- Read FAQ's
- Explore our social media
- Sign up for our email list
- And more!

